

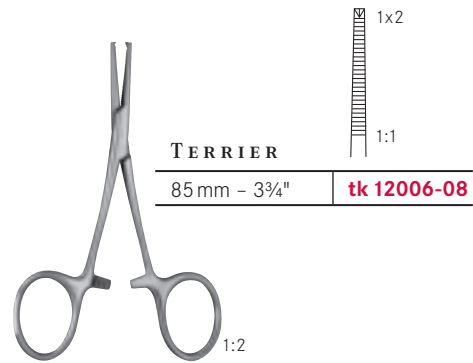

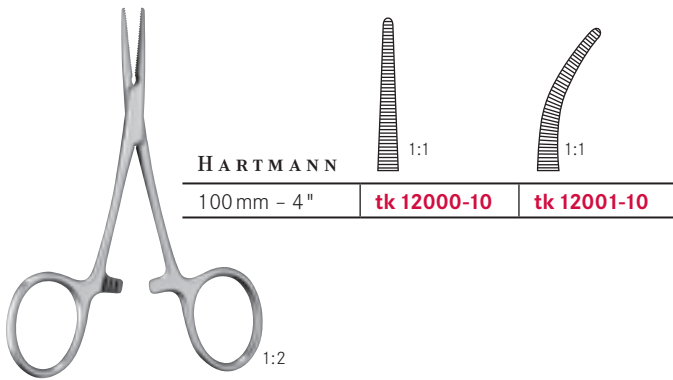

Arterienklemmen
Haemostatic forceps

Pincès hémostatiques
Pinzas hemostáticas
Pinze emostatiche



HALSTED- MOSQUITO				
	125 mm - 5"	tk 12010-12	tk 12011-12	tk 12012-12
140 mm - 5½"	tk 12010-14	tk 12011-14	tk 12012-14	tk 12013-14
			1x2	1x2

125 mm - 5"	tk 12110-12	tk 12111-12	tk 12112-12	tk 12113-12
Titan			1x2	1x2
Titanium				
Titane				
Titanio				
Titanio				



Arterienklemmen
Haemostatic forceps

Pinces hémostatiques
Pinzas hemostáticas
Pinze emostatiche

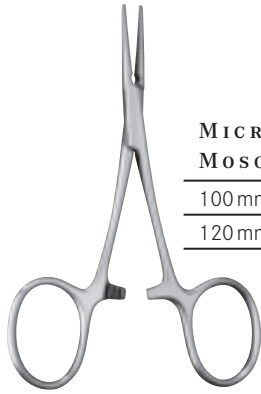

MICRO-
MOSQUITO

100 mm - 4"	tk 12020-10	tk 12021-10	tk 12022-10	tk 12023-10
120 mm - 4¾"	tk 12020-12	tk 12021-12	tk 12022-12	tk 12023-12

1x2

1x2



PROVIDENCE-
HOSPITAL

140 mm - 5½"	tk 12020-14	tk 12021-14
--------------	-------------	-------------

1:2

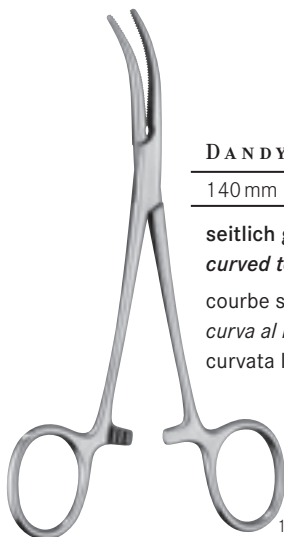

DANDY

140 mm - 5½"	tk 12030-14	tk 12032-14
--------------	-------------	-------------

seitlich gebogen
curved to the side
courbe sur le plat
curva al lado
curvata lateralmente

1x2

1:2

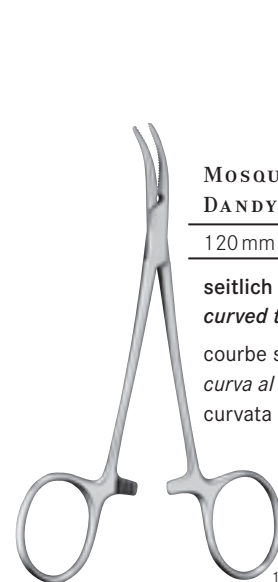

MOSQUITO-
DANDY

120 mm - 4¾"	tk 12031-12
--------------	-------------

seitlich gebogen
curved to the side
courbe sur le plat
curva al lado
curvata lateralmente

1:2

Arterienklemmen
Haemostatic forceps

Pinces hémostatiques
Pinzas hemostáticas
Pinze emostatiche

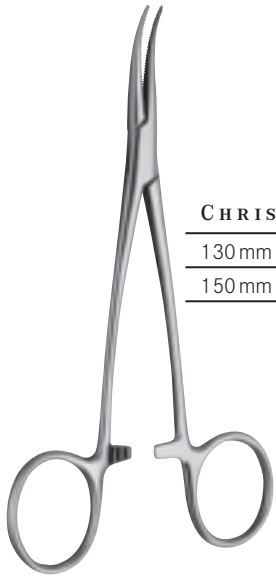

CHRISTOPHE

130 mm - 4"	tk 12039-13
150 mm - 6"	tk 12039-15

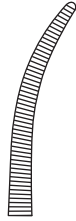

LOVELACE

155 mm - 6"	tk 12195-15	tk 12196-15
-------------	-------------	-------------

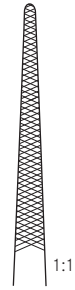
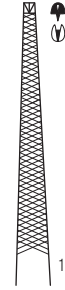

1x2

1:2



LERICHE

150 mm - 6"	tk 12034-15	tk 12035-15
-------------	-------------	-------------

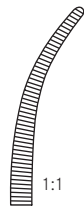
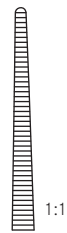

1:2



LERICHE

150 mm - 6"	tk 12036-15	tk 12037-15
-------------	-------------	-------------

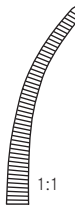
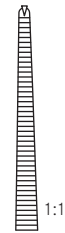

1x2

1x2

1:2

Arterienklemmen
Haemostatic forceps

Pinces hémostatiques
Pinzas hemostáticas
Pinze emostatiche

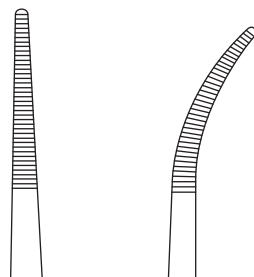

KELLY

140 mm - 5½"	tk 12040-14	tk 12041-14
--------------	-------------	-------------

KELLY-RANKIN

160 mm - 6¼"	tk 12040-16	tk 12041-16
--------------	-------------	-------------

KELLY

140 mm - 5½"	tk 12140-14	tk 12141-14
--------------	-------------	-------------

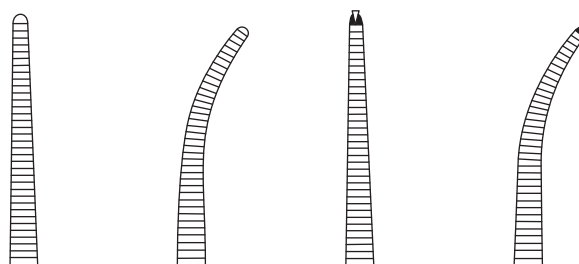

CRILE

140 mm - 5½"	tk 12050-14	tk 12051-14	tk 12052-14	tk 12053-14
--------------	-------------	-------------	-------------	-------------

1x2

1x2

CRILE-RANKIN

160 mm - 6¼"	tk 12050-16	tk 12051-16	tk 12054-16	tk 12055-16
--------------	-------------	-------------	-------------	-------------

1x2

1x2

CRILE

140 mm - 5½"	tk 12250-14	tk 12251-14
--------------	-------------	-------------



Arterienklemmen
Haemostatic forceps

Pinces hémostatiques
Pinzas hemostáticas
Pinze emostatiche

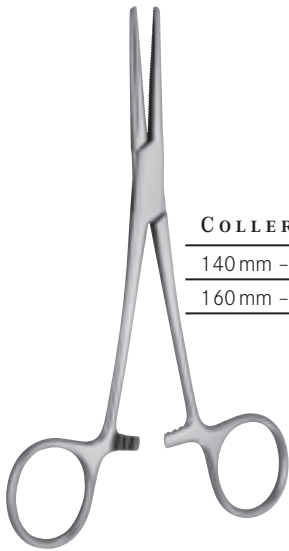

COLLER

140 mm - 5½"	tk 12056-14	tk 12057-14
160 mm - 6¼"	tk 12056-16	tk 12057-16

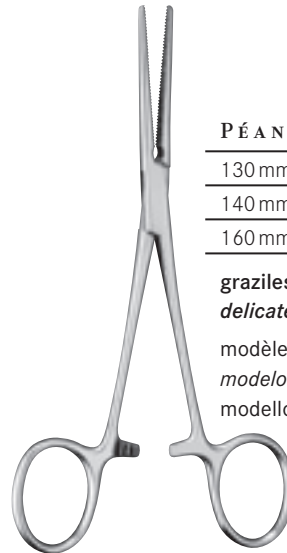
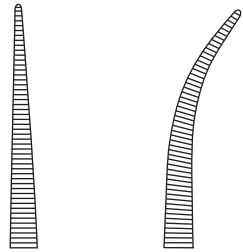

PÉAN

130 mm - 5"	tk 12058-13	tk 12059-13
140 mm - 5½"	tk 12058-14	tk 12059-14
160 mm - 6¼"	tk 12058-16	tk 12059-16

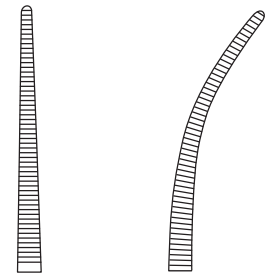

graziles Modell
delicate pattern
modèle délicat
modelo delicado
modello delicato



DUNHILL

125 mm - 5"	tk 12268-12
-------------	--------------------

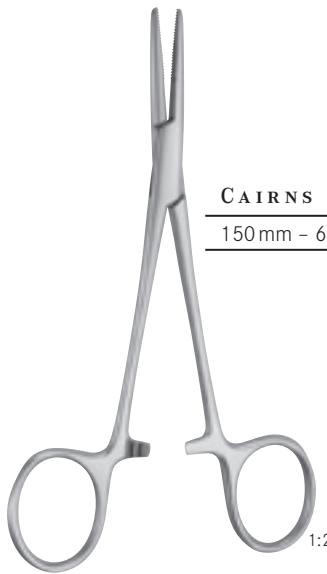
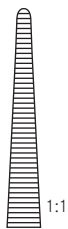

CAIRNS

150 mm - 6"	tk 12269-01	tk 12269-02
-------------	--------------------	--------------------

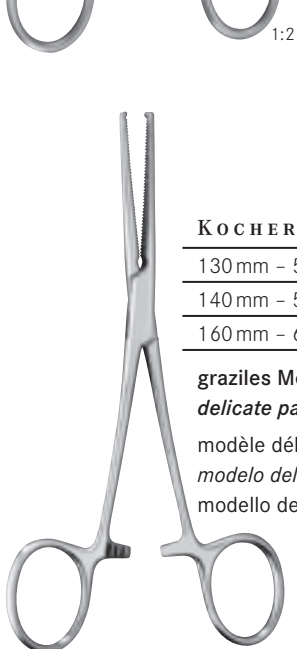
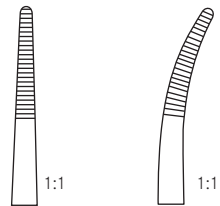

KOCHER

130 mm - 5"	tk 12078-13	tk 12079-13
140 mm - 5½"	tk 12078-14	tk 12079-14
160 mm - 6¼"	tk 12078-16	tk 12079-16

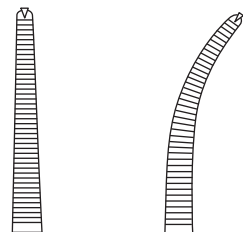

graziles Modell
delicate pattern
modèle délicat
modelo delicado
modello delicato

Präparier- und Ligaturklemmen
Dissecting and ligature forceps

Pinces à disséquer et à sutures
Pinzas para preparación y suturas
Pinze per preparazioni e suture



OVERHOLT-
GEISSENDOERFER

	Fig. 0	Fig. 1	Fig. 2	Fig. 3
210 mm - 8¼"	tk 12280-21	tk 12281-21	tk 12282-21	tk 12283-21
270 mm - 10¾"	tk 12280-27	tk 12281-27	tk 12282-27	tk 12283-27

	Fig. 4	Fig. 5	Fig. 6
210 mm - 8¼"	tk 12284-21	tk 12285-21	tk 12286-21
270 mm - 10¾"	tk 12284-27	tk 12285-27	tk 12286-27

Präparier- und Ligaturklemmen
Dissecting and ligature forceps

Pinces à disséquer et à sutures
Pinzas para preparación y suturas
Pinze per preparazioni e suture



GEMINI

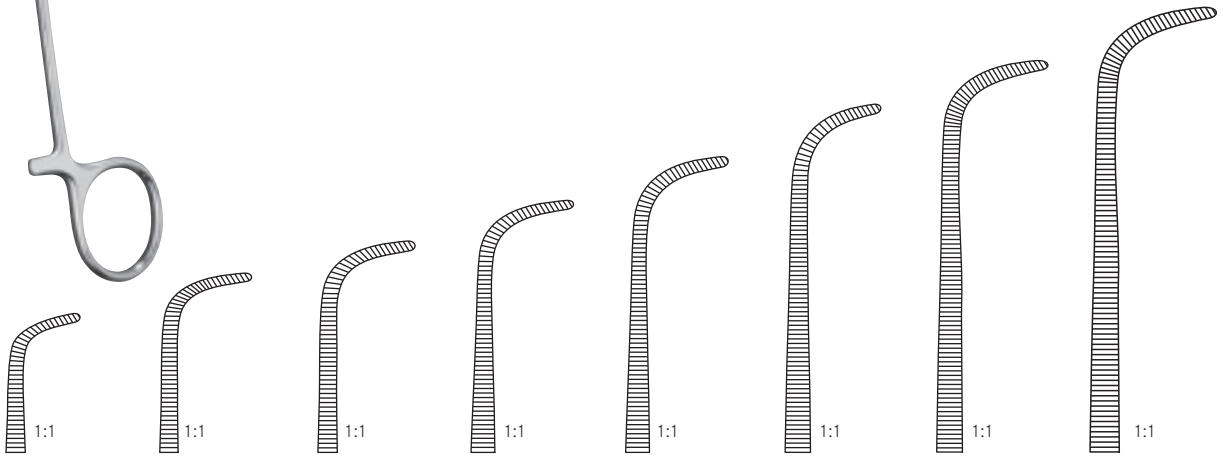

130 mm - 5"	160 mm - 6¼"	180 mm - 7"	200 mm - 8"	230 mm - 9"	250 mm - 9¾"	280 mm - 11"	350 mm - 14"
tk 12290-13	tk 12290-16	tk 12290-18	tk 12290-20	tk 12290-23	tk 12290-25	tk 12290-28	tk 12290-35



MINI-GEMINI

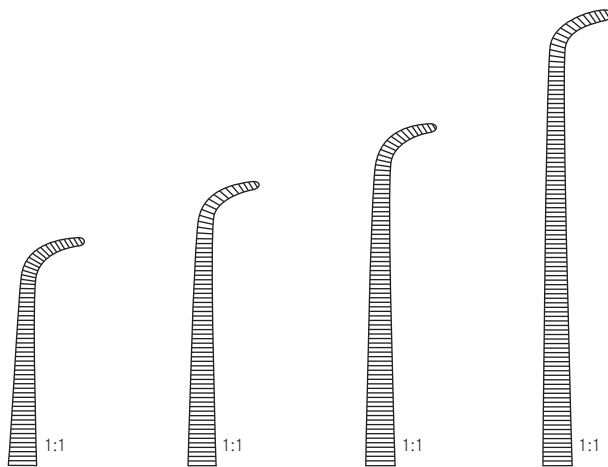

180 mm - 7"	220 mm - 8¾"	250 mm - 9¾"	280 mm - 11"
tk 12291-18	tk 12291-22	tk 12291-25	tk 12291-28

Gewebe- und Darmfasszangen
Tissue and intestinal holding forceps

Pinces intestinales et de tissue
Pinzas para tejidos y intestinos
Pinze per tessuti ed intestinali



LITTLEWOOD
190mm - 7½" **tk 11955-19**

Zähne 2x3
Teeth
Dents
Dientes
Denti



BOYS-ALLIS
150mm - 6" **tk 28210-15**

Zähne 5x6
Teeth
Dents
Dientes
Denti



JUDD-ALLIS
150mm - 6" **tk 28250-15**
190mm - 7½" **tk 28250-19**

Zähne 3x4
Teeth
Dents
Dientes
Denti



BABCOCK

160mm - 6¼"	200mm - 8"
tk 28285-16	tk 28285-20

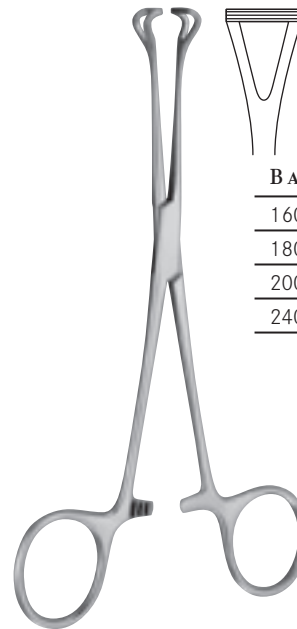

BABCOCK

160mm - 6¼"	tk 28280-16
180mm - 7"	tk 28280-18
200mm - 8"	tk 28280-20
240mm - 9½"	tk 28280-24

Gewebe- und Darmfazzangen
Tissue and intestinal holding forceps

Pinces intestinales et de tissue
Pinzas para tejidos y intestinos
Pinze per tessuti ed intestinali

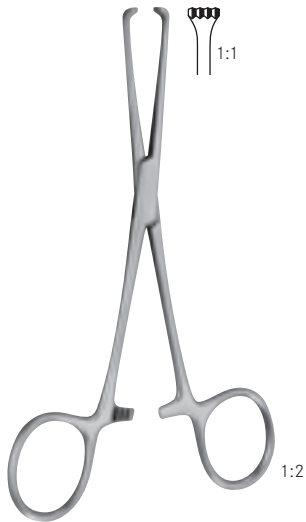

ALLIS-BABY

130 mm - 5" **tk 28100-14**

Zähne 4x5
Teeth

Dents
Dientes
Denti



ALLIS

150 mm - 6"	tk 28140-15	tk 28160-15
190 mm - 7½"		tk 28160-19
250 mm - 9¾"		tk 28160-25

Zähne 4x5 5x6
Teeth
Dents
Dientes
Denti



ALLIS-ADAIR

155 mm - 6" **tk 28167-15**

Zähne 10x11
Teeth

Dents
Dientes
Denti



THOMS-ALLIS

200 mm - 8" **tk 28180-20**

6x7



LOCKWOOD

200 mm - 8" **tk 28190-20**

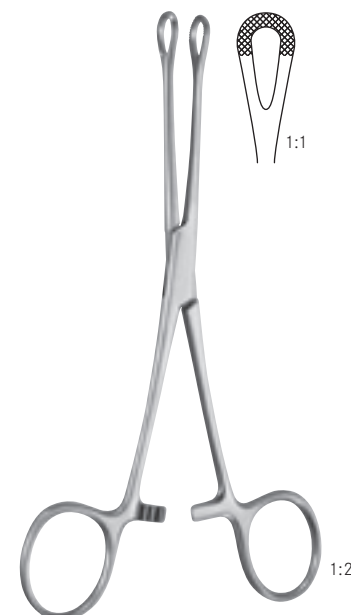

WILLIAMS

160 mm - 6¼" **tk 28192-16**

Tuchklemmen
Towel forceps

Pinces à champs
Pinzas de campo
Pinze fissateli



BERNHARD

100 mm - 4"	tk 12800-10
120 mm - 4¾"	tk 12800-12
140 mm - 5½"	tk 12800-14
165 mm - 6½"	tk 12800-16
180 mm - 7"	tk 12800-18



BACKHAUS

90 mm - 3½"	tk 12805-09
110 mm - 4¼"	tk 12805-11
130 mm - 5"	tk 12805-13
150 mm - 6"	tk 12805-15



ROEDER

130 mm - 5"	tk 12802-13
150 mm - 6"	tk 12802-15



110 mm - 4" tk 12807-11

mit Schlauchhalter
with clip for tube
avec porte-tuyeau
con soporte de tubo
con supporto per tubo

Tuchklemmen
Towel forceps

Pinces à champs
Pinzas de campo
Pinze fissateli



ROBIN

135 mm - 5¼" tk 12809-13

mit Schlauchhalter bis 5 mm Ø
with clip for tube up to 5 mm Ø

avec porte-tuyeau à 5 mm Ø
con soporte de tubo hasta 5 mm Ø
con supporto per tubo fino a 5 mm Ø



JONES

50 mm - 2" tk 12810-05
90 mm - 3½" tk 12810-09



SCHAEDEL

90 mm - 3½" tk 12820-09



DOYEN

180 mm - 7" tk 12825-18

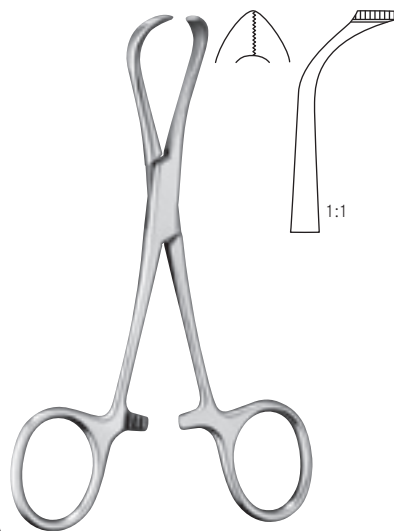

LORNA

100 mm - 4" tk 12830-10
130 mm - 5" tk 12830-13

Tuchklemmen
Towel forceps

Pinces à champs
Pinzas de campo
Pinze fissateli



LANE

130 mm - 5"	tk 12840-13
150 mm - 6"	tk 12840-15
200 mm - 8"	tk 12840-20

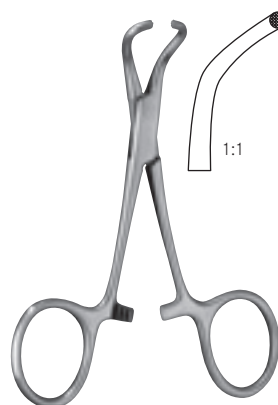

TOHOKU-JAPAN

100 mm - 4"	tk 12845-10
130 mm - 5"	tk 12845-13



PEERS-BERTRAM

145 mm - 5¾"	tk 12847-14
--------------	-------------



90 mm - 3½"	tk 12801-09
115 mm - 4½"	tk 12850-11
130 mm - 5"	tk 12850-13

für Papierabdeckung
for paper clothes

pour couvertures en papier
para paños de papel
per copertura di carta

Kornzangen
Polypus and dressing forceps

Pinces à polypes et à pansements
Pinzas para pólipos y vendajes
Pinze per medicazione e polipi

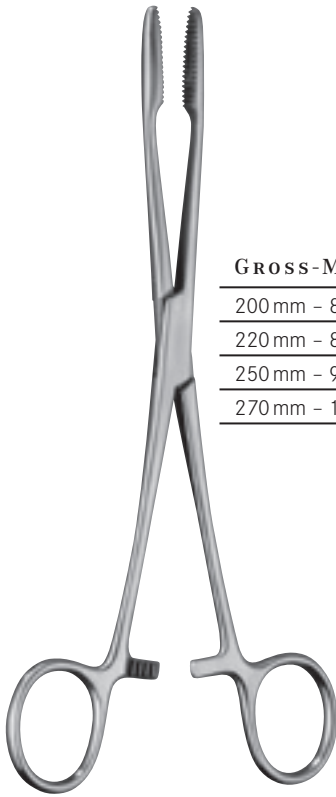

GROSS-MAIER

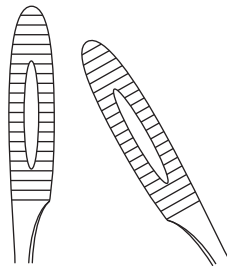

200 mm - 8"	tk 15110-20	tk 15111-20
220 mm - 8¾"	tk 15110-22	tk 15111-22
250 mm - 9¾"	tk 15100-25	tk 15101-25
270 mm - 10¾"	tk 15100-27	tk 15101-27

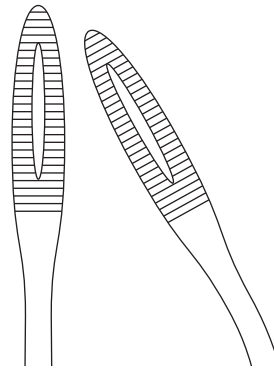

MAIER

200 mm - 8"	tk 15112-20	tk 15113-20
250 mm - 9¾"	tk 15102-25	tk 15103-25



ULRICH

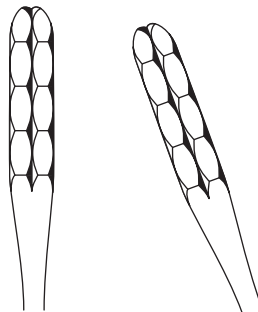

220 mm - 8¾"	tk 15120-22	tk 15121-22
250 mm - 9¾"	tk 15120-25	tk 15121-25
270 mm - 10¾"	tk 15120-27	tk 15121-27
350 mm - 14"	tk 15120-35	tk 15121-35

Schwammzangen
Sponge holding forceps

Pinces à éponges
Pinzas para esponjas
Pinze per tamponi



FOERSTER
(BALENGER)

180 mm - 7"	tk 15180-18	tk 15182-18	tk 15183-18	tk 15185-18
200 mm - 8"		tk 15182-20		tk 15185-20
250 mm - 9¾"	tk 15180-25	tk 15182-25	tk 15183-25	tk 15185-25
300 mm - 12"		tk 15182-30		
350 mm - 14"		tk 15182-35		
400 mm - 16"		tk 15182-40		

Trachealhäkchen
Trachea retractors

Ecarteurs tracheales
Separadores traqueales
Uncini tracheali

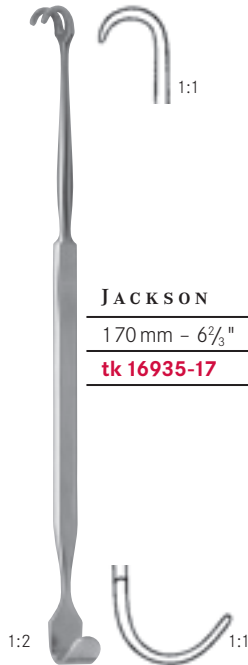

JACKSON

170 mm - 6 $\frac{2}{3}$ "

tk 16935-17



JACKSON

180 mm - 7"

tk 16937-18

tk 16939-18

stumpf

scharf

blunt

sharp

mousse

pointu

romo

agudo

smusso

acuto

Wundhaken
Retractors

Ecarteurs
Separadores
Divaricatori

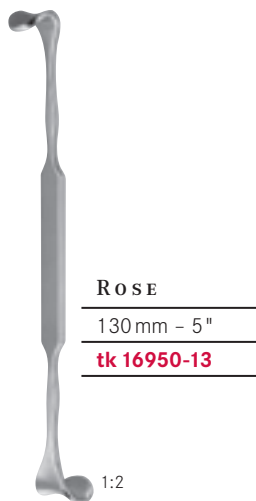

ROSE

130 mm - 5"

tk 16950-13



LUER

110 mm - 4 $\frac{1}{4}$ "

tk 16952-11







SCHOENBORN

210 mm - 8 $\frac{1}{4}$ "





tk 16955-21





Wundhaken | Ecarteurs
 Retractors | Separadores
 Divaricatori



EMMET	 1:1	 1:1	 1:1	 1:1	 1:1
	Fig. 1	Fig. 2	Fig. 3	Fig. 4	Fig. 5
	220 mm - 8 3/4"	tk 16958-01	tk 16958-02	tk 16958-03	tk 16958-04

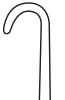

scharf sharp pointu agudo acuto	 1:1	 1:1	 1:1	 1:1	
	160 mm - 6 1/4"	tk 17001-16	tk 17002-16	tk 17003-16	tk 17004-16

stumpf blunt mousse romo smusso	 1:1	 1:1	 1:1	 1:1	
	160 mm - 6 1/4"	tk 17011-16	tk 17012-16	tk 17013-16	tk 17014-16

Wundhaken
Retractors

Ecarteurs
Separadores
Divaricatori



1:2



1:1



1:1



1:1

160 mm - 6 1/4"	tk 17021-16	tk 17022-16	tk 17024-16
-----------------	--------------------	--------------------	--------------------

flexibel, scharf
flexible, sharp
flexible, pointu
flexible, agudo
flessibile, acuto

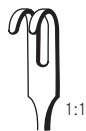

1:1



1:1

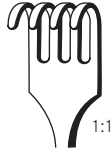

1:1

160 mm - 6 1/4"	tk 17031-16	tk 17032-16	tk 17034-16
-----------------	--------------------	--------------------	--------------------

flexibel, stumpf
flexible, blunt
flexible, mousse
flexible, romo
flessibile, smusso



1:1

DESMARRES



1:1



1:1



1:1

	x = 8 mm	x = 10 mm	x = 12 mm
160 mm - 6 1/4"	tk 17038-08	tk 17038-10	tk 17038-12



1:1



1:1



1:1

	x = 14 mm	x = 16 mm	x = 18 mm
160 mm - 6 1/4"	tk 17038-14	tk 17038-16	tk 17038-18

160 mm - 6 1/4"

1:2



1:1

1:2

KNAPP
(ROLLET)

160 mm - 6 1/4"

tk 17025-16

flexibel, scharf
flexible, sharp
flexible, pointu
flexible, agudo
flessibile, acuto

Wundhaken
Retractors

Ecarteurs
Separadores
Divaricatori



MINI-LANGENBECK

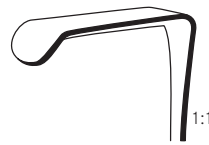

	10 mm x 6 mm	17 mm x 5 mm	20 mm x 6 mm	22 mm x 8 mm
160 mm - 6 1/4"	tk 17039-10	tk 17039-17	tk 17039-20	tk 17039-22

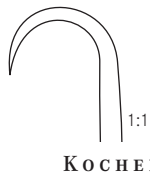

KOCHER

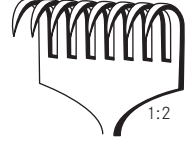
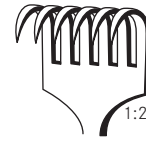

220 mm - 8 3/4"	tk 17041-22	tk 17042-22	tk 17043-22	tk 17044-22	tk 17046-22	tk 17048-22
-----------------	-------------	-------------	-------------	-------------	-------------	-------------

scharf
sharp
pointu
agudo
acuto

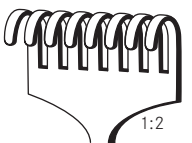
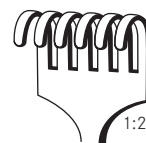
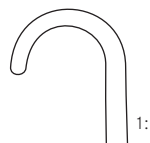

220 mm - 8 3/4"	tk 17051-22	tk 17052-22	tk 17053-22	tk 17054-22	tk 17056-22	tk 17058-22
-----------------	-------------	-------------	-------------	-------------	-------------	-------------

stumpf
blunt
mousse
romo
smusso

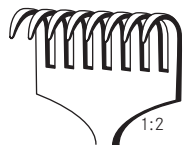
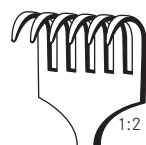
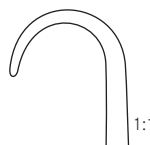

220 mm - 8 3/4"	tk 17059-01	tk 17059-02	tk 17059-03	tk 17059-04	tk 17059-06	tk 17059-08
-----------------	-------------	-------------	-------------	-------------	-------------	-------------

halbscharf
semi-sharp
semi-pointu
semi-agudo
semi-acuto

Wundhaken
Retractors

Ecarteurs
Separadores
Divaricatori



VOLKMANN

215 mm - 8½ "

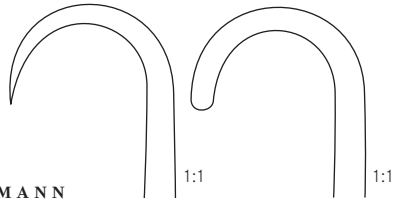

tk 17040-01

tk 17040-02

scharf

sharp

pointu

agudo

acuto

stumpf

blunt

mousse

romo

smusso



SENN-MILLER

160 mm - 6¼ "

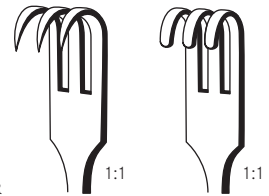

tk 17080-16

tk 17081-16

scharf

sharp

pointu

agudo

acuto

stumpf

blunt

mousse

romo

smusso



13 mm x 5 mm

KILNER

155 mm - 6 "

tk 17082-15

1:2

1:1

Wundhaken
Retractors

Ecarteurs
Separadores
Divaricatori



STRANDELL-
STILLE

	20 mm x 6 mm	20 mm x 6 mm
190 mm - 7½"	tk 17079-01	tk 17079-02

gezahnt
saw edge
dentelé
dentado
dentato

1:2

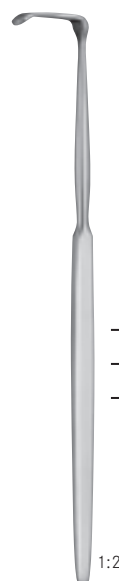

SENN-GREEN

	20 mm x 6 mm	10 mm x 6 mm
150 mm - 6"	tk 17083-01	tk 17083-02

1:2



RAGNELL-
DAVIS

140 mm - 5½"	tk 17084-14
--------------	--------------------

15 mm x 5,5 mm

1:2

1:1



COTTLE

150 mm - 6"	tk 17085-15
-------------	--------------------

1:2

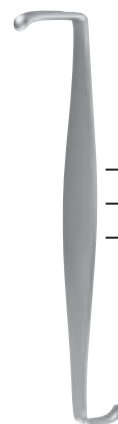

CRILE

110 mm - 4¼"	tk 17088-11
--------------	--------------------



1:2



Wundhaken
Retractors

Ecarteurs
Separadores
Divaricatori







LANGENBECK



	 1:1	 1:1	 1:1
	Fig. 1	Fig. 2	Fig. 3
	30 mm x 11 mm	30 mm x 14 mm	30 mm x 16 mm
210 mm - 8¼"	tk 17112-01	tk 17112-02	tk 17112-03

	 1:1	 1:1
	Fig. 4	Fig. 5
	40 mm x 11 mm	50 mm x 11 mm
210 mm - 8¼"	tk 17112-04	tk 17112-05



KOCHER-LANGENBECK
(OBWEGESER)

	 1:2	 1:2	 1:2	 1:2
	25 mm x 7 mm	35 mm x 8 mm	35 mm x 11 mm	35 mm x 15 mm
215 mm - 8½"	tk 17114-01	tk 17114-02	tk 17114-03	tk 17114-04

	 1:2	 1:2	 1:2
	42 mm x 10 mm	55 mm x 12 mm	70 mm x 14 mm
215 mm - 8½"	tk 17114-05	tk 17114-06	tk 17114-07

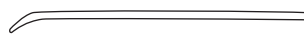
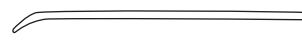
	 1:2	 1:2
	80 mm x 12 mm	80 mm x 16 mm
215 mm - 8½"	tk 17114-08	tk 17114-09

Wundsperrer
Self-retaining retractors

Ecarteurs autostatiques
Separadores autoestáticos
Divaricatori autostatici

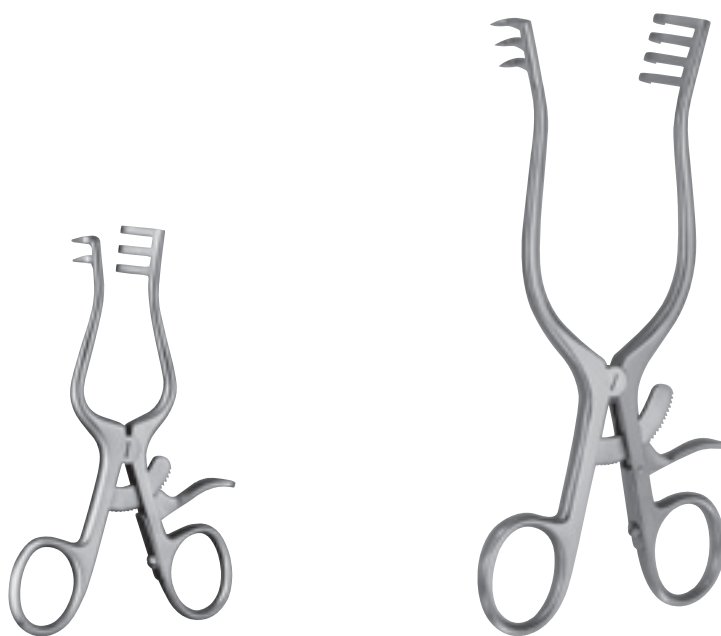
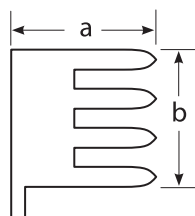

WEITLANER-LOKTITE

105 mm - 4¼"	a=17 mm - b=13 mm	tk 17400-10	tk 17400-20	tk 17401-10			
130 mm - 5"	a=17 mm - b=17 mm				tk 17402-13	tk 17402-23	tk 17403-13
165 mm - 6½"	a=17 mm - b=17 mm				tk 17402-16	tk 17402-26	tk 17403-16
200 mm - 8"	a=20 mm - b=19 mm				tk 17404-20	tk 17404-30	tk 17405-20
260 mm - 10¼"	a=26 mm - b=21 mm				tk 17404-26	tk 17404-36	tk 17405-26
		2 x 3 scharf sharp pointu agudo acuto	2 x 3 halbscharf semi sharp semi pointu semi agudo semi acuto	2 x 3 stumpf blunt mousse romo smusso	3 x 4 scharf sharp pointu agudo acuto	3 x 4 halbscharf semi sharp semi pointu semi agudo semi acuto	3 x 4 stumpf blunt mousse romo smusso

Wundsperrer
Self-retaining retractors

Ecarteurs autostatiques
Separadores autoestáticos
Divaricatori autostatici



ALM

70 mm - 2¾"	tk 17330-07	tk 17330-17	tk 17331-07
100 mm - 4"	tk 17330-10	tk 17330-20	tk 17331-10

scharf <i>sharp</i>	halbscharf <i>semi sharp</i>	stumpf <i>blunt</i>
pointu <i>agudo</i>	semi pointu <i>semi agudo</i>	mousse <i>romo</i>
acuto	semi acuto	smusso



HOLTZHEIMER

100 mm - 4"	tk 17336-10	tk 17337-10
-------------	--------------------	--------------------

scharf <i>sharp</i>	stumpf <i>blunt</i>
pointu <i>agudo</i>	mousse <i>romo</i>
acuto	smusso



BOSE

70 mm - 2¾"
tk 17395-07



JANSEN

100 mm - 4"	tk 17480-01	tk 17480-02
110 mm - 4¼"		tk 17482-11

scharf <i>sharp</i>	stumpf <i>blunt</i>
pointu <i>agudo</i>	mousse <i>romo</i>
acuto	smusso

Tränenkanal-Dilatatoren
Lacrimal Dilators

Dilatateurs pour le canal lacrymal
Dilatadores para el canal lacrimal
Dilatatori lacrimali



BOWMAN

Tränenkanal-Dilatator
Lacrimal Dilators

Dilatateurs pour le canal lacrymal
Dilatadores para el canal lacrimal
Dilatatori lacrimali

Fig. 000 / 00	Fig. 00 / 0	Fig. 0 / 1	Fig. 1 / 2	Fig. 2 / 3
tk 40099-00	tk 40100-00	tk 40100-01	tk 40100-12	tk 40100-23
0.4 / 0.6 mm Ø	0.7 / 0.8 mm Ø	0.8 / 0.9 mm Ø	0.9 / 1.1 mm Ø	1.1 / 1.3 mm Ø

geknöpft
probe

boutonné
botonado
botonuti

Fig. 3 / 4	Fig. 4 / 5	Fig. 5 / 6	Fig. 6 / 7	Fig. 7 / 8
tk 40100-34	tk 40100-45	tk 40100-56	tk 40100-67	tk 40100-78
1.3 / 1.4 mm Ø	1.4 / 1.5 mm Ø	1.5 / 1.6 mm Ø	1.6 / 1.8 mm Ø	1.8 / 1.9 mm Ø

geknöpft
probe

boutonnés
botonado
botonuti

Fig. 000 / 00	Fig. 00 / 0	Fig. 0 / 1	Fig. 1 / 2	Fig. 2 / 3
tk 40101-00	tk 40102-00	tk 40102-01	tk 40102-12	tk 40102-23
0.4 / 0.6 mm Ø	0.7 / 0.8 mm Ø	0.8 / 0.9 mm Ø	0.9 / 1.1 mm Ø	1.1 / 1.3 mm Ø

zylindrisch

cylindrical
cylindriques
cilindrico
cilindrico

Fig. 3 / 4	Fig. 4 / 5	Fig. 5 / 6	Fig. 6 / 7	Fig. 7 / 8
tk 40102-34	tk 40102-45	tk 40102-56	tk 40102-67	tk 40102-78
1.3 / 1.4 mm Ø	1.4 / 1.5 mm Ø	1.5 / 1.6 mm Ø	1.6 / 1.8 mm Ø	1.8 / 1.9 mm Ø

zylindrisch

cylindrical
cylindriques
cilindrico
cilindrico