

Anatomische Pinzetten - Chirurgische Pinzetten
Dressing forceps - Dissecting forceps

Pinces à dissection - Pinces à dissection à griffes
Pinzas de disección - Pinzas de disección con dientes
 Pinze per dissezione - Pinze per dissezione con denti



SEMKEN

125 mm - 5"	tk 10300-12	tk 11300-12
150 mm - 6"	tk 10300-15	tk 11300-15

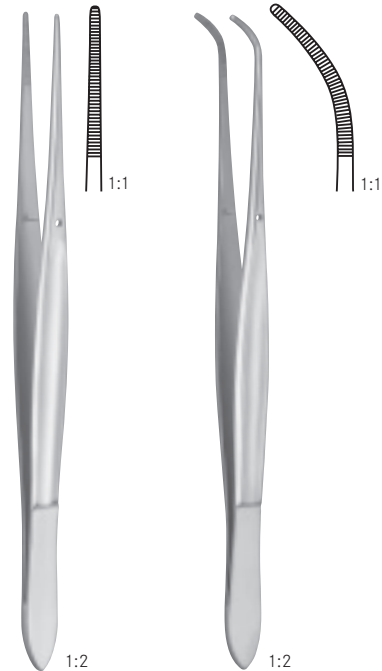

CUSHING

175 mm - 7"	tk 10400-17	tk 10401-17
175 mm - 7"	tk 10402-17 TC	

Anatomische Pinzetten - Chirurgische Pinzetten
Dressing forceps - Dissecting forceps

Pinces à dissection - Pinces à dissection à griffes
 Pinzas de disección - Pinzas de disección con dientes
 Pinze per dissezione - Pinze per dissezione con denti



GILLIES
 150 mm - 6"
tk 11250-15



MC INDOE
 150 mm - 6" **tk 10550-15**
 150 mm - 6" **tk 11640-15 TC**



WANGENSTEEN
 150 mm - 6" **tk 10608-15**
 230 mm - 9" **tk 10608-23**

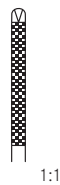

OEHLER

	140 mm - 5½"	160 mm - 6¼"	180 mm - 7"
	tk 11690-14 TC	tk 11690-16 TC	tk 11690-18 TC



	200 mm - 8"	250 mm - 9¾"	300 mm - 12"
	tk 11690-20 TC	tk 11690-25 TC	tk 11690-30 TC

Anatomische Pinzetten - Chirurgische Pinzetten
Dressing forceps - Dissecting forceps

Pinces à dissection - Pinces à dissection à griffes
Pinzas de disección - Pinzas de disección con dientes
 Pinze per dissezione - Pinze per dissezione con denti

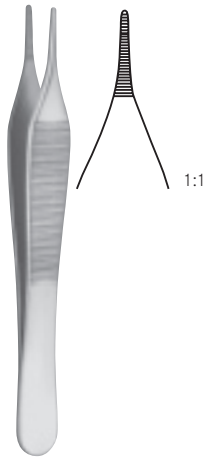

ADSON

120 mm - 4¾"	tk 10500-12
150 mm - 6"	tk 10500-15
120 mm - 4¾"	tk 10502-12 TC
150 mm - 6"	tk 10502-15 TC



MICRO-ADSON

120 mm - 4¾"	tk 10503-12
150 mm - 6"	tk 10503-15



ADSON-GRAEFE

120 mm - 4¾"	tk 11212-12
--------------	--------------------



ADSON BROWN

120 mm - 4¾"	tk 11210-12
120 mm - 4¾"	tk 10508-12 TC

Anatomische Pinzetten - Chirurgische Pinzetten
Dressing forceps - Dissecting forceps

Pinces à dissection - Pinces à dissection à griffes
 Pinzas de disección - Pinzas de disección con dientes
 Pinze per dissezione - Pinze per dissezione con denti



ADSON

120 mm - 4 3/4"	tk 11200-12	tk 11204-12
150 mm - 6"	tk 11200-15	
120 mm - 4 3/4"	tk 10504-12 TC	
150 mm - 6"	tk 10504-15 TC	

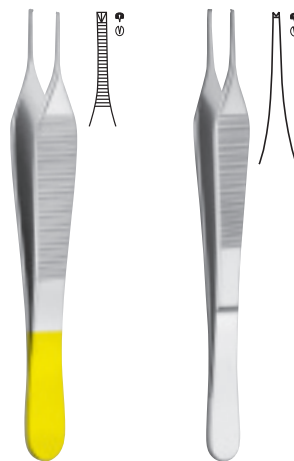

MICRO-ADSON

tk 11202-12	tk 11206-12
tk 11202-15	tk 11206-15
tk 10506-12 TC	
tk 10506-15 TC	



ADSON

120 mm - 4 3/4"
tk 11206-13

mit Fadenplatte 1 mm
with tying platform 1 mm
 avec plateforme pour sutures 1 mm
con plataforma para suturas 1 mm
 con piattaforma per suture 1 mm



**ULTRA-MICRO-ADSON
 (BRAKA)**

120 mm - 4 3/4"
tk 11206-12B

mit Fadenplatte 1 mm
with tying platform 1 mm
 avec plateforme pour sutures 1 mm
con plataforma para suturas 1 mm
 con piattaforma per suture 1 mm

Anatomische Pinzetten - Chirurgische Pinzetten
Dressing forceps - Dissecting forceps

Pincas à dissection - Pincas à dissection à griffes
Pinzas de disección - Pinzas de disección con dientes
Pinze per dissezione - Pinze per dissezione con denti



GRAEFE

105 mm - 4 1/4"

tk 11700-10

tk 11701-10

tk 11703-10

tk 11730-10

tk 11731-10

tk 11733-10

Anatomische Pinzetten - Chirurgische Pinzetten
Dressing forceps - Dissecting forceps

Pinces à dissection - Pinces à dissection à griffes
 Pinzas de disección - Pinzas de disección con dientes
 Pinze per dissezione - Pinze per dissezione con denti



ADLERKREUTZ

150 mm - 6"	tk 11086-15	tk 11087-15
200 mm - 8"	tk 11086-20	tk 11087-20
250 mm - 9¾"		tk 11087-25



WAUGH

150 mm - 6"	tk 10616-15
200 mm - 8"	tk 10616-20
250 mm - 9¾"	tk 10616-25



DUEHRSSSEN

200 mm - 8"

tk 10604-20



105 mm - 4¼"

tk 11635-10

Columella Pinzette
Columella forceps

Pince à columella
 Pinza para columella
 Pinze per columella

Anatomische Pinzetten - Chirurgische Pinzetten
Dressing forceps - Dissecting forceps

Pinces à dissection - Pinces à dissection à griffes
Pinzas de disección - Pinzas de disección con dientes
 Pinze per dissezione - Pinze per dissezione con denti



POTTS-SMITH

180 mm - 7"	tk 11150-18	tk 11151-18
210 mm - 8¼"	tk 11150-21	tk 11151-21
250 mm - 9¾"	tk 11150-25	tk 11151-25



BROPHY

200 mm - 8"	tk 11100-20	tk 11101-20
-------------	--------------------	--------------------

Anatomische Pinzetten - Chirurgische Pinzetten
Dressing forceps - Dissecting forceps

Pinces à dissection - Pinces à dissection à griffes
 Pinzas de disección - Pinzas de disección con dientes
 Pinze per dissezione - Pinze per dissezione con denti



TAYLOR

175 mm - 7"

tk 10310-17

tk 10312-17

tk 10313-17



GERALD

180 mm - 7"

tk 10324-18

tk 10325-18

tk 10326-19

Atraumatische Pinzetten
Atraumatic tissue forceps

Pinces atraumatiques
Pinzas de disección atraumáticas
Pinze per dissezione atraumatiche

ATRAUMTK



DE BAKEY-GERALD	
150 mm - 6"	tk 10327-15
180 mm - 7"	tk 10327-18





DE BAKEY BAYONET	
180 mm - 7"	tk 10328-18
200 mm - 8"	tk 10328-20

Atraumatische Pinzetten
Atraumatic tissue forceps

Pinces atraumatiques
Pinzas de disección atraumáticas
 Pinze per dissezione atraumatiche

ATRAUMTK



DE BAKEY		
	x = 1.5 mm	x = 2.0 mm
120 mm - 4¾"	tk 11960-12	
145 mm - 5¾"	tk 11960-14	tk 11964-14
160 mm - 6¼"	tk 11960-16	tk 11964-16
200 mm - 8"	tk 11960-20	tk 11964-20
240 mm - 9½"	tk 11960-24	tk 11964-24
300 mm - 12"		tk 11964-30

Atraumatische Pinzetten
Atraumatic tissue forceps

Pinces atraumatiques
Pinzas de disección atraumáticas
Pinze per dissezione atraumatiche

TUCAR**TK**

ATRAUM**TK**

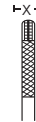
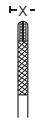

DE B A K E Y

	x = 1.5 mm	x = 2.0 mm
150 mm - 6"	tk 11968-15 TC	tk 11969-15 TC
190 mm - 7½"	tk 11968-19 TC	tk 11969-19 TC
240 mm - 9½"	tk 11968-24 TC	tk 11969-24 TC

Mikro-Pinzetten
Micro forceps

Pinces micro
Micro pinzas
Micro pinze



	x = 0.3 mm	x = 0.5 mm
150 mm - 6"	tk 25686-30	
180 mm - 7"		tk 25686-35

mit Fadenplatte
with tying platform

avec plateforme pour sutures
con plataforma para suturas
con piattaforma per suture



	x = 0.3 mm	x = 0.5 mm
150 mm - 6"	tk 25687-30	
180 mm - 7"		tk 25687-335

mit Fadenplatte
with tying platform

avec plateforme pour sutures
con plataforma para suturas
con piattaforma per suture

Mikro-Pinzetten
Micro forceps

Pinces micro
Micro pinzas
Micro pinze



TYP
JUWELIER

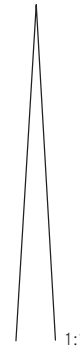
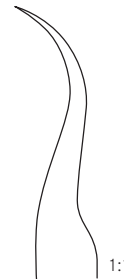
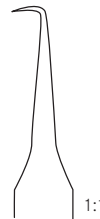
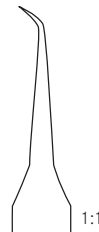

x = 0.2 mm	x = 0.3 mm	x = 0.3 mm	x = 0.2 mm	x = 0.3 mm
110 mm - 4¼"	110 mm - 4¼"	110 mm - 4¼"	120 mm - 4¾"	120 mm - 4¾"
tk 26001-11	tk 26002-11	tk 26003-11	tk 26005-12	tk 26006-13

Mikro-Pinzetten
Micro forceps

Pinces micro
Micro pinzas
Micro pinze



PIERSE

120 mm - 4¾"	tk 26009-12
135 mm - 5"	tk 26009-13

Gefäßdilatoren
Vessel dilators

Dilatateurs vasculaires
Dilatadores vasculares
Dilatatori vascolari

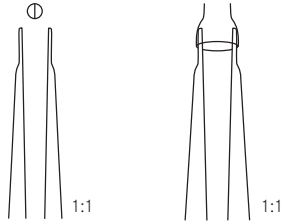

	x = 0.2 mm	x = 0.3 mm
110 mm - 4 1/4"	tk 26015-02	tk 26015-03

sehr fein
very fine
très fin
muy fino
molto fino



	x = 0.3 mm
150 mm - 6"	tk 26015-04
180 mm - 7"	tk 26015-05

mit Fadenplatte
with tying platform
avec plateforme pour sutures
con plataforma para suturas
con piattaforma per suture

Approximatoren, Gefäßclips nach Biemer
Approximators, Biemer clips

Approximateurs, clips selon Biemer
Approximadores, Biemer clips
Approssimatori, clips vascolari Biemer



1:3

BIEMER

	tk 25209-02	tk 25209-01
	Anlegepinzette mit Schloss <i>applying forceps with lock</i> pince à poser avec verrou <i>aplicadora con cierre</i> pinza posa clips con cremagliera	Anlegepinzette ohne Schloss <i>applying forceps without lock</i> pince à poser sans verrou <i>aplicadora sin cierre</i> pinza posa clips senza cremagliera



	x	y	gms
	Maullänge <i>jaw length</i> longueur du mors <i>longitud de la boca</i> lunghezza del morso	max. Maulöffnung <i>max. jaw opening</i> ouverture max. du mors <i>apertura max. de la boca</i> apertura mass.	Schließkraft <i>closing pressure</i> force de fermeture <i>fuerza de cierre</i> pressione

tk 25210-00	tk 25211-00	tk 25212-00	tk 25213-00
--------------------	--------------------	--------------------	--------------------

x = 6 mm
y = 4 mm
30 gms - 40 gms

x = 9 mm
y = 5 mm
30 gms - 40 gms

x = 9 mm
y = 5 mm
20 gms - 25 gms

x = 4,5 mm
y = 3,0 mm
30 gms - 40 gms

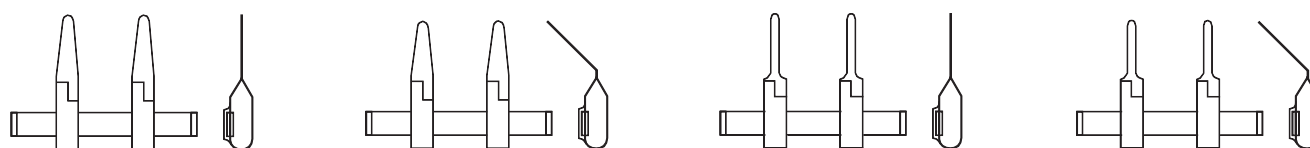

tk 25214-00	tk 25215-00	tk 25216-00	tk 25217-00
--------------------	--------------------	--------------------	--------------------

x = 9 mm
y = 5 mm
30 gms - 40 gms

x = 9 mm
y = 5 mm
30 gms - 40 gms

x = 9 mm
y = 5 mm
20 gms - 25 gms

x = 9 mm
y = 5 mm
30 gms - 40 gms

Für temporären Gebrauch, (gekennzeichnet durch gelb eingefärbte Federenden) für Gefäße mit 0,5 mm - 2,0 mm Ø. Maulinnenflächen schräg gerieft für schonendes und sicheres Festhalten der Gefäße. Der fest eingestellte Schliessdruck gewährt risikofreie Anwendung

For temporary occlusion, (identified by yellow coloured spring ends) for vessels of 0,5 mm - 2,0 mm Ø. Blade gripping surface with oblique serrations for save but careful gripping of vessels. No risk due to rigidly fixed pressure measure

Pour usage temporaire, (ressorts couleur jaune) pour vaisseau de 0,5 mm - 2,0 mm Ø. Mors striés pour fixation sûr et menagement. Force du fermeture non changeable

Para oclusión temporal (ressortes amarillos) para vasos de 0,5 mm - 2,0 mm Ø. Boca estriada para fijación segura y moderada de los vasos. Utilización sin riesgo con fuerza de oclusión fija

Per uso temporaneo, con finale della molla giallo, per vasi di 0,5 mm - 2,0 mm Ø. Morso zignanto per una presa sicura, non traumatica

Anlegepinzetten für Gefäßclips
Applying forceps for vessel clips
Pinces à poser des clips
Aplicadoras para clips
Pinze per mettere clips

140 mm - 5½"	tk 25059-01	tk 25059-02
--------------	--------------------	--------------------

ohne Schloß <i>without lock</i>	mit Schloß <i>with lock</i>
sans serrure <i>sin cierre</i>	avec serrure <i>con cierre</i>
senza cremagliera	con cremagliera



140 mm - 5½"	tk 25059-03
--------------	--------------------

für Approximatoren und Doppelklemmen
for approximators and double-clips
 pour approximateurs et clips doubles
para aproximadores y clips dobles
 per approssimatori e clips doppi

x	Ø	V	A
Länge <i>Length</i>	Gefäß <i>Vessel</i>	Vene <i>Vein</i>	Arterie <i>Artery</i>
Longueur	Vaisseau	Veine	Artère
<i>Longitud</i>	Vaso	Vena	Arteria
Lunghezza	Vaso	Vena	Arteria

Weitere Modelle und Ausführungen auf Anfrage
Other models and executions upon request
 Autres modèles et exécutions sur demande
Otros modelos y ejecuciones segun demanda
 Altri modelli a richiesta

50 x 25 x 4.5 mm	75 x 25 x 4.5 mm	70 x 45 x 8 mm
tk 55210-01	tk 55210-02	tk 55210-03

Lagerungstrays für Gefäßclips
Trays for storage of vessel clips

 Boîtes pour clips vasculaires
Cajas para clips vasculares
 Scatole per clips vascolari

Approximatoren, Gefäßclips
Approximators, clips

Approximateurs, clips
Approximadores, clips
Approssimatori, clips vascolari

x = 8 mm				
V	tk 25060-01	tk 25060-02	tk 25060-03	tk 25060-04
A	tk 25070-01	tk 25070-02	tk 25070-03	tk 25070-04
Ø = 0,4 mm - 1 mm				
x = 11 mm				
V	tk 25061-01	tk 25061-02	tk 25061-03	tk 25061-04
A	tk 25071-01	tk 25071-02	tk 25071-03	tk 25071-04
Ø = 0,6 mm - 1,5 mm				
x = 14 mm				
V	tk 25062-01	tk 25062-02	tk 25062-03	tk 25062-04
A	tk 25072-01	tk 25072-02	tk 25072-03	tk 25072-04
Ø = 1 mm - 2 mm				
x = 17 mm				
V	tk 25063-01	tk 25063-02	tk 25063-03	tk 25063-04
A	tk 25073-01	tk 25073-02	tk 25073-03	tk 25073-04
Ø = 1 mm - 2,25 mm				
x = 25 mm				
V	tk 25064-01	tk 25064-02	tk 25064-03	tk 25064-04
A	tk 25074-01	tk 25074-02	tk 25074-03	tk 25074-04
Ø = 1,5 mm - 3,5 mm				
x = 36 mm				
V	tk 25065-01	tk 25065-02	tk 25065-03	tk 25065-04
A	tk 25075-01	tk 25075-02	tk 25075-03	tk 25075-04
Ø = 1,5 mm - 3,5 mm				

PRIMUSLINE

Arterienklemmen
Haemostatic forceps

Pinces hémostatiques
Pinzas hemostáticas
Pinze emostatiche

Muß eine PRIMUSLINE Klemme abgebildet sein!

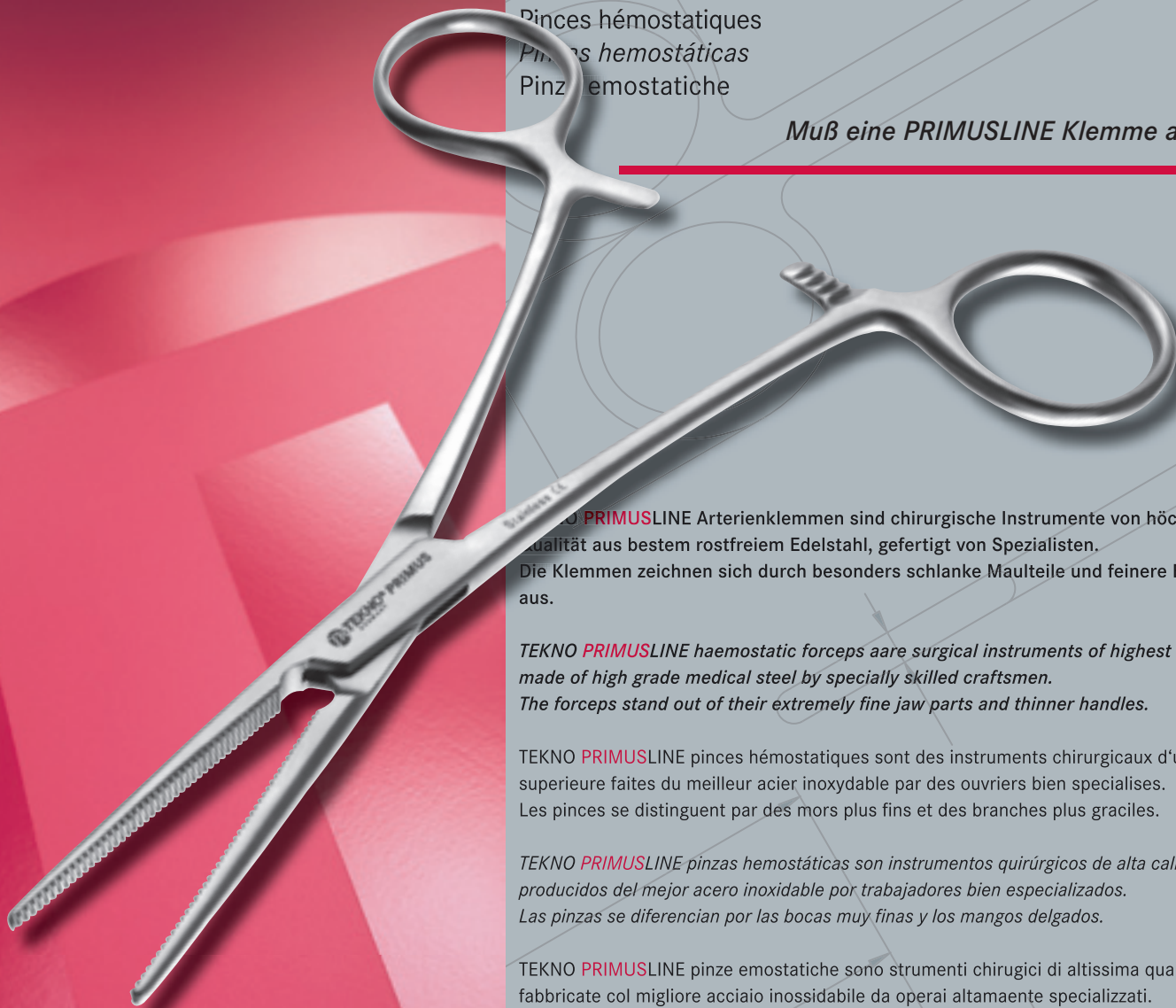

Die **PRIMUSLINE** Arterienklemmen sind chirurgische Instrumente von höchster Qualität aus bestem rostfreiem Edelstahl, gefertigt von Spezialisten. Die Klemmen zeichnen sich durch besonders schlanke Maulteile und feinere Branchen aus.

TEKNO PRIMUSLINE haemostatic forceps are surgical instruments of highest quality, made of high grade medical steel by specially skilled craftsmen. The forceps stand out of their extremely fine jaw parts and thinner handles.

TEKNO **PRIMUSLINE** pinces hémostatiques sont des instruments chirurgicaux d'une qualité supérieure faites du meilleur acier inoxydable par des ouvriers bien spécialisés. Les pinces se distinguent par des mors plus fins et des branches plus graciles.

TEKNO PRIMUSLINE pinzas hemostáticas son instrumentos quirúrgicos de alta calidad, producidos del mejor acero inoxidable por trabajadores bien especializados. Las pinzas se diferencian por las bocas muy finas y los mangos delgados.

TEKNO **PRIMUSLINE** pinze emostatiche sono strumenti chirurgici di altissima qualità, fabbricate col migliore acciaio inossidabile da operai altamente specializzati. Le pinze si differenziano per il morso e le branche fini.

Gewebe- und Darmfasszangen
Tissue and intestinal holding forceps

Pinces intestinales et de tissu
Pinzas para intestinos y tejidos
 Pinze per tessuti ed intestino

PRIMUSLINE



BABCOCK

160 mm - 6 1/4"	tk 28280-16-P
180 mm - 7"	tk 28280-18-P
200 mm - 8"	tk 28280-20-P



ALLIS

150 mm - 6"	tk 28140-15-P	tk 28160-15-P
190 mm - 7 1/2"		tk 28160-19-P



Zähne 4x5 5x6
 Teeth
 Dents
 Dientes
 Denti

Arterienklemmen
Haemostatic forceps

Pinces hémostatiques
Pinzas hemostáticas
Pinze emostatiche





PRIMUSLINE



HARTMANN	 1:1	 1:1
100 mm - 4"	tk 12000-10-P	tk 12001-10-P

1:2







MICRO-MOSQUITO				
100 mm - 4"	tk 12020-10-P	tk 12021-10-P	tk 12022-10-P	tk 12023-10-P
120 mm - 4 3/4"	tk 12020-12-P	tk 12021-12-P	tk 12022-12-P	tk 12023-12-P

1x2

1x2



HALSTED-MOSQUITO				
125 mm - 5"	tk 12010-12-P	tk 12011-12-P	tk 12012-12-P	tk 12013-12-P
140 mm - 5 1/2"	tk 12010-14-P	tk 12011-14-P	tk 12012-14-P	tk 12013-14-P

1x2

1x2

Arterienklemmen
Haemostatic forceps

Pinces hémostatiques
Pinzas hemostáticas
Pinze emostatiche

PRIMUSLINE



KELLY

140 mm - 5 1/2"	tk 12040-14-P	tk 12041-14-P
-----------------	----------------------	----------------------

KELLY-RANKIN

160 mm - 6 1/4"	tk 12040-16-P	tk 12041-16-P
-----------------	----------------------	----------------------

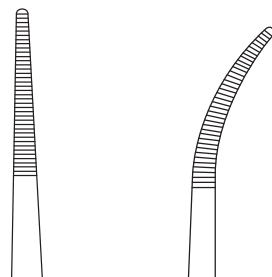

CRILE

140 mm - 5 1/2"	tk 12050-14-P	tk 12051-14-P
-----------------	----------------------	----------------------

CRILE-RANKIN

160 mm - 6 1/4"	tk 12050-16-P	tk 12051-16-P
-----------------	----------------------	----------------------

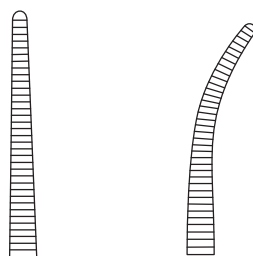

Arterienklemmen
Haemostatic forceps

Pinces hémostatiques
Pinzas hemostáticas
Pinze emostatiche

PRIMUSLINE

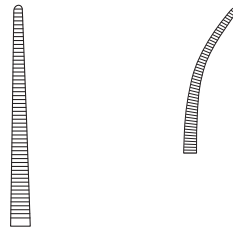

P É A N

130 mm - 5"	tk 12058-13-P	tk 12059-13-P
140 mm - 5½"	tk 12058-14-P	tk 12059-14-P
160 mm - 6¼"	tk 12058-16-P	tk 12059-16-P

graziles Modell
delicate pattern
modèle délicat
modelo delicado
modello delicato

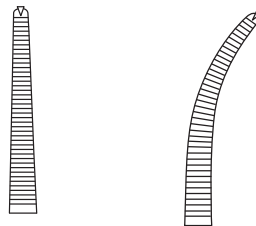

K O C H E R

130 mm - 5"	tk 12078-13-P	tk 12079-13-P
140 mm - 5½"	tk 12078-14-P	tk 12079-14-P
160 mm - 6¼"	tk 12078-16-P	tk 12079-16-P

graziles Modell
delicate pattern
modèle délicat
modelo delicado
modello delicato

1x2





1x2

Arterienklemmen
Haemostatic forceps



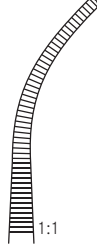

Pinces hémostatiques
Pinzas hemostáticas
Pinze emostatiche

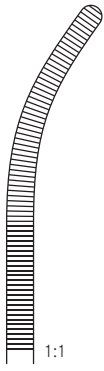
PRIMUSLINE



PÉAN-FINO	 1:1	 1:1	 1:1	 1:1	 1:1	 1:1
	145 mm - 5 3/4"	165 mm - 6 1/2"	185 mm - 7 1/4"	140 mm - 5 1/2"	160 mm - 6 1/4"	180 mm - 7"
	tk 12062-14-P	tk 12062-16-P	tk 12062-18-P	tk 12063-14-P	tk 12063-16-P	tk 12063-18-P

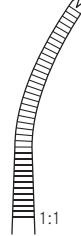

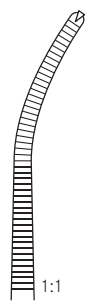
KOCHER-FINO	 1:1	 1:1	 1:1	 1:1	 1:1	 1:1
	145 mm - 5 3/4"	165 mm - 6 1/2"	185 mm - 7 1/4"	145 mm - 5 3/4"	160 mm - 6 1/4"	180 mm - 7"
	tk 12082-14-P	tk 12082-16-P	tk 12082-18-P	tk 12083-14-P	tk 12083-16-P	tk 12083-18-P
	1x2	1x2	1x2	1x2	1x2	1x2

Arterienklemmen
Haemostatic forceps

Pinces hémostatiques
Pinzas hemostáticas
Pinze emostatiche



1:2

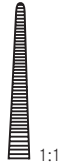

1:1

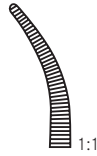

1:1

HARTMANN

100 mm - 4"	tk 12000-10	tk 12001-10
-------------	--------------------	--------------------



**HALSTED-
MOSQUITO**

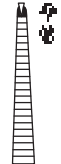

125 mm - 5"	tk 12010-12	tk 12011-12	tk 12012-12	tk 12013-12
140 mm - 5½"	tk 12010-14	tk 12011-14	tk 12012-14	tk 12013-14

1x2

1x2

125 mm - 5"	tk 12110-12	tk 12111-12	tk 12112-12	tk 12113-12
-------------	--------------------	--------------------	--------------------	--------------------

Titan
Titanium
Titane
Titanio
Titanio



1x2

1x2



**MICRO-
MOSQUITO**

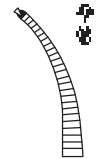
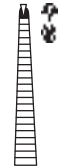

100 mm - 4"	tk 12020-10	tk 12021-10	tk 12022-10	tk 12023-10
120 mm - 4¾"	tk 12020-12	tk 12021-12	tk 12022-12	tk 12023-12

Arterienklemmen
Haemostatic forceps

Pinces hémostatiques
Pinzas hemostáticas
Pinze emostatiche



1:2

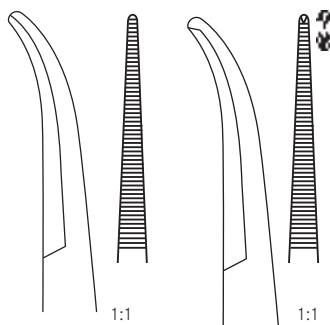

1:1

1:1

DANDY

140 mm - 5 1/2"

tk 12030-14

tk 12032-14

seitlich gebogen
curved to the side
courbe sur le plat
curva al lado
curvata lateralmente

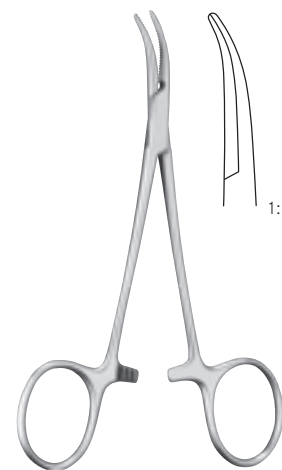

1:2

MOSQUITO-DANDY

tk 12031-12

120 mm - 4 3/4"

seitlich gebogen
curved to the side
courbe sur le plat
curva al lado
curvata lateralmente



1:2

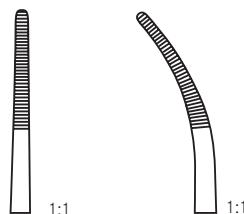

1:1

1:1

PROVIDENCE-HOSPITAL

140 mm - 5 1/2"

tk 12020-14

tk 12021-14

Arterienklemmen
Haemostatic forceps

Pinces hémostatiques
Pinzas hemostáticas
Pinze emostatiche

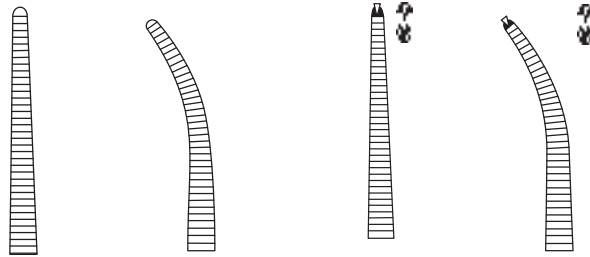

CRILE

140 mm - 5 1/2"	tk 12050-14	tk 12051-14	tk 12052-14	tk 12053-14
-----------------	-------------	-------------	-------------	-------------

CRILE-RANKIN

160 mm - 6 1/4"	tk 12050-16	tk 12051-16	tk 12054-16	tk 12055-16
-----------------	-------------	-------------	-------------	-------------

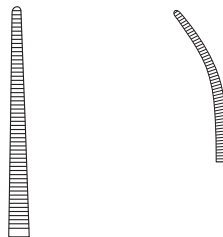

PÉAN

130 mm - 5"	tk 12058-13	tk 12059-13
140 mm - 5 1/2"	tk 12058-14	tk 12059-14
160 mm - 6 1/4"	tk 12058-16	tk 12059-16

graziles Modell
delicate pattern
modèle délicat
modelo delicado
modello delicato

Arterienklemmen
Haemostatic forceps

Pinces hémostatiques
Pinzas hemostáticas
Pinze emostatiche

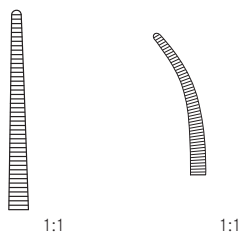

LERICHE		
150 mm - 6"	tk 12034-15	tk 12035-15

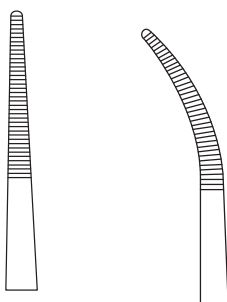

KELLY		
140 mm - 5 1/2"	tk 12040-14	tk 12041-14

KELLY-RANKIN		
160 mm - 6 1/4"	tk 12040-16	tk 12041-16

Arterienklemmen
Haemostatic forceps

Pinces hémostatiques
Pinzas hemostáticas
Pinze emostatiche

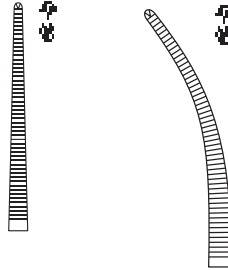

KOCHER

130 mm - 5"	tk 12078-13	tk 12079-13
140 mm - 5½"	tk 12078-14	tk 12079-14
160 mm - 6¼"	tk 12078-16	tk 12079-16

graziles Modell
delicate pattern
modèle délicat
modelo delicado
modello delicato

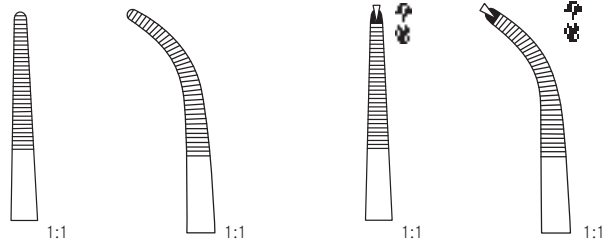

ADSON

185 mm - 7¼"	tk 12210-18	tk 12211-18	tk 12212-18	tk 12213-18
--------------	--------------------	--------------------	--------------------	--------------------

1:2

Arterienklemmen
Haemostatic forceps

Pinces hémostatiques
Pinzas hemostáticas
Pinze emostatiche

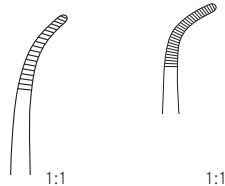
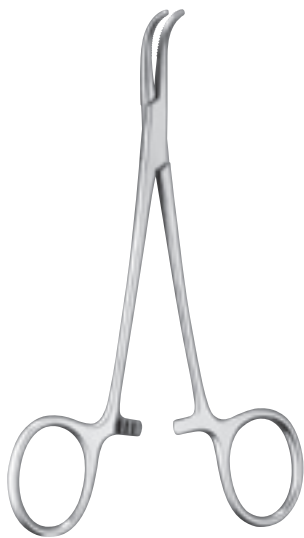

BABY-MIXTER

140 mm - 5 1/2"	tk 12220-14	
180 mm - 7"		tk 12220-18

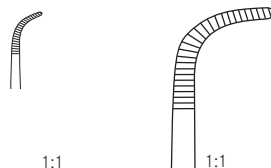

BABY-ADSON

140 mm - 5 1/2"	tk 12221-14	
180 mm - 7"		tk 12221-18

Gewebe- und Darmfazzangen
Tissue and intestinal holding forceps

Pinces intestinales et de tissue
Pinzas para tejidos y intestinos
Pinze per tessuti ed intestinali

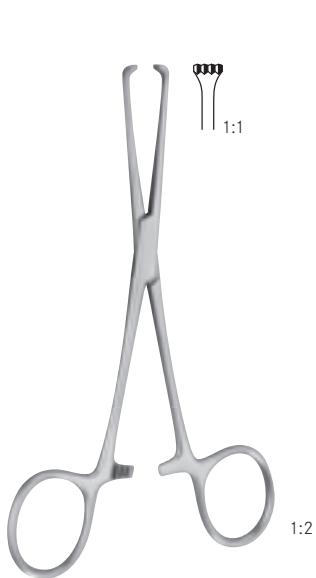

ALLIS-BABY

130 mm - 5"

tk 28100-14

4 x 5



ALLIS

150 mm - 6"

tk 28140-15

tk 28160-15

190 mm - 7½"

tk 28160-19

250 mm - 9¾"

tk 28160-25

4 x 5

5 x 6



ALLIS-ADAIR

155 mm - 6"

tk 28167-15

10 x 11



THOMS-ALLIS

200 mm - 8"

tk 28180-20

6 x 7



LOCKWOOD

200 mm - 8"

tk 28190-20

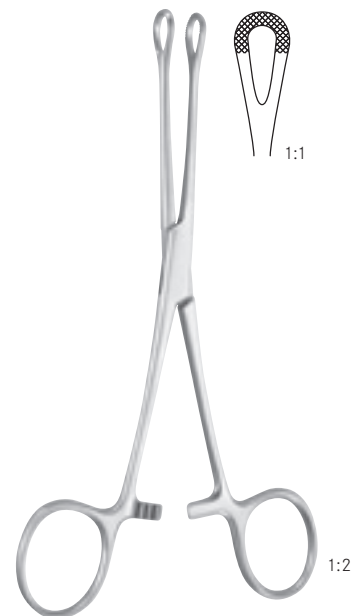

WILLIAMS

160 mm - 6¼"

tk 28192-16

Tupfer- und Schwammzangen
Cotton swab forceps, sponge holding forceps

Pinces à tampons et éponges
Pinzas para tampones y esponjas
Pinze per tamponi

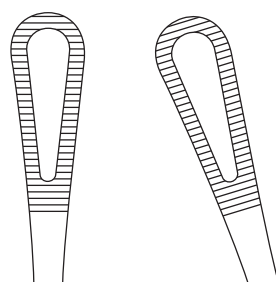

RAMPLEY

180 mm - 7"	tk 15130-18	tk 15131-18
250 mm - 10"	tk 15130-25	tk 15131-25



FOERSTER (BALLENGER)

180 mm - 7"	tk 15180-18	tk 15182-18	tk 15183-18	tk 15185-18
200 mm - 8"		tk 15182-20		tk 15185-20
250 mm - 10"	tk 15180-25	tk 15182-25	tk 15183-25	tk 15185-25